

CM4 Industrial

Industrial Computer for IoT, Industrial Control and Automation

EDA TECHNOLOGY CO.,LTD



Highlight

- ◆ Powerful performance with Quad-core CPU, up to 8GB RAM and up to 32GB eMMC
- ◆ Dual LAN support with 1x Gig-Ethernet and 1x Fast Ethernet
- ◆ Support a wide range of wireless including Dual-band WiFi, Bluetooth and 4G LTE with Optional GPS
- ◆ Rich Industrial Interface with 7 ~ 36V DC Power Input, RTC, SPI Flash, 1x RS232, 2x RS485, 3x ADC Channels, 2x isolated DI and 1x SPDT Relay
- ◆ Full meta case with Fan support, Support DIN-rail mounting



Introduction

CM4 Industrial is an industrial embedded computer based on Raspberry Pi Compute Module 4. The system can be configured by 1GB/2GB/4GB/8GB RAM and 0GB/8GB/16GB/32GB eMMC according to different applications, supporting SD card startup.

It provides a variety of industrial communication interfaces and functions, such as RS232, RS485, high-precision ADC, isolated IO input, relay control, real-time clock of battery backup and alarm buzzer. Besides, 1x Ethernet interface with PoE function, 1x 10/100M port, 4G/LTE module, external antenna support, certified 2.4/5.8G dual-band WIFI and Bluetooth are also provided. Moreover, CM4 Industrial supports official 1x 8-megapixel camera, 1x DSI display port and 1x FPC HDMI port.

Other features of CM4 Industrial are also worth mentioning, for example, onboard 32Mb serial Flash is used to store system data, power supply is available in a wide range of 7 ~ 36V, and ESD protection is provided for all important interfaces.

The users can add more functions on the board through Mini-PCIe interface, the standard 40 pins connector, 2x 4-pin USB interface for internal expansion, 1x TTL electric level Uart interface, etc. to fully utilize its powerful communication capability to satisfy all kinds of requirement in CM4 Industrial.



Specifications

Category	Feature
Processor	Broadcom BCM2711 quad-core Cortex-A72 (ARM v8) 64-bit SoC @ 1.5GHz H.265 (HEVC) (up to 4Kp60 decode), H.264 (up to 1080p60 decode, 1080p30 encode) OpenGL ES 3.1, Vulkan 1.0
RAM	1GB / 2GB / 4GB / 8GB LPDDR4-3200 SDRAM
Storage	Onboard 0GB / 8GB / 16GB / 32GB eMMC 1x microSD Card Slot for system boot when choosing 0GB(CM4 Lite) eMMC Onboard 32Mbits SPI Flash
Display	1x standard HDMI Out (Type A) 1x FPC HDMI Touch Display 1x FPC DSI Touch Display
Camera	1x FPC CSI, Support Raspberry Pi Official 5M & 8M Cameras
Wired Interface	1x Gig-Ethernet (10/100/1000M), Support PoE (with Raspberry Pi PoE HAT) 1x Fast-Ethernet (10/100M) 2x USB 2.0 Type-A 1x USB micro-B for eMMC Flashing (Inside the case)
Wireless	Optional 2.4 GHz, 5.0 GHz IEEE 802.11 b/g/n/ac wireless and Bluetooth 5.0, BLE with external antenna Optional 4G LTE with optional GPS support, 1x Standard-SIM card slot, external antenna
Industrial Interface	2x RS485, 6-pin Terminal Block 1x RS232, 3-pin Terminal Block 3x 12-bits ADC Channels, 4-pin Terminal Block 2x isolated DI, Support Dry / Wet Contact 1x SPDT Relay, 6-pin Terminal Block 1x RTC with CR1220 backup 1x adjustable speed fan control, 3-pin wafer connector 1x Buzzer
Expansion Interface	1x mini-PCIe slot with 1-lane PCIe and 1x USB 2.0, Support 4G Module 1x standard Raspberry Pi 40-PIN GPIO 1x Serial(TTL), 4-pin DIP connector 2x USB 2.0, 4-pin DIP connector 1x non-isolated IO, 2-pin DIP connector
Power In	7 ~ 36V DC DC Jack or optional 2-pin Terminal Block
Indicator	1x Power Indicator with Red LED 1x Status Indicator with Green LED 1x 4G network indicator with Blue LED (Inside the case)
Buttons	1x System Reset Button 1x User Button
Operating Temperature Range	-25 ~ 50°C
Operating Humidity	10% - 60%
Case	Metal Case, 2 Antenna Holes
Dimension	147(L) x 119(W) x 28(H) mm
Mounting Options	DIN-mount Wall-mount
OS	Pre-installed with 32-bit Raspberry Pi OS with Desktop in eMMC(if choosing eMMC variants) Compatible with Origin Raspberry Pi OS, support 32-bit and 64-bit OS, support Lite and Desktop versions Support BSP online install / upgrade with APT tool

Interface Diagram

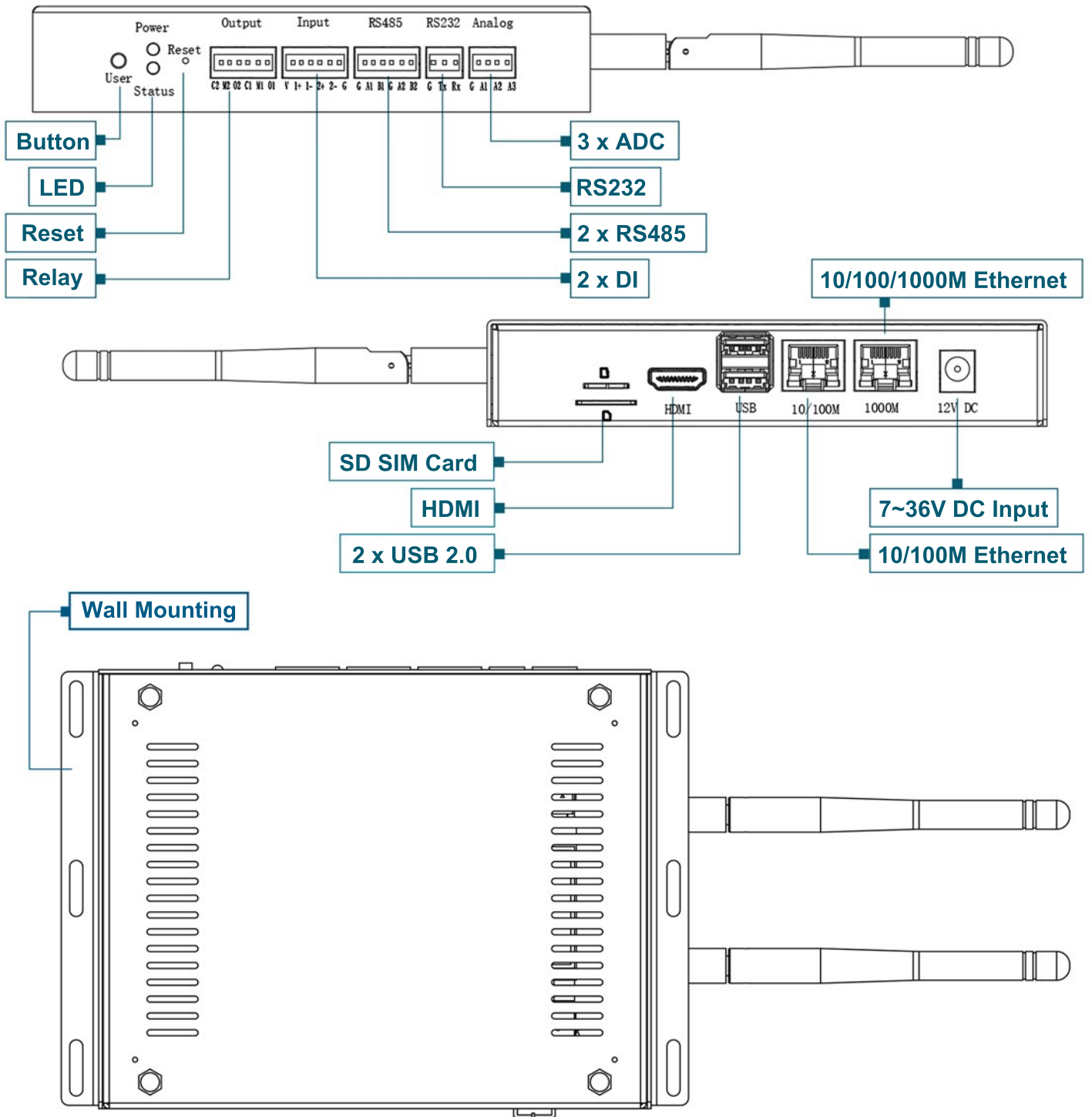

Dimension Unit:mm

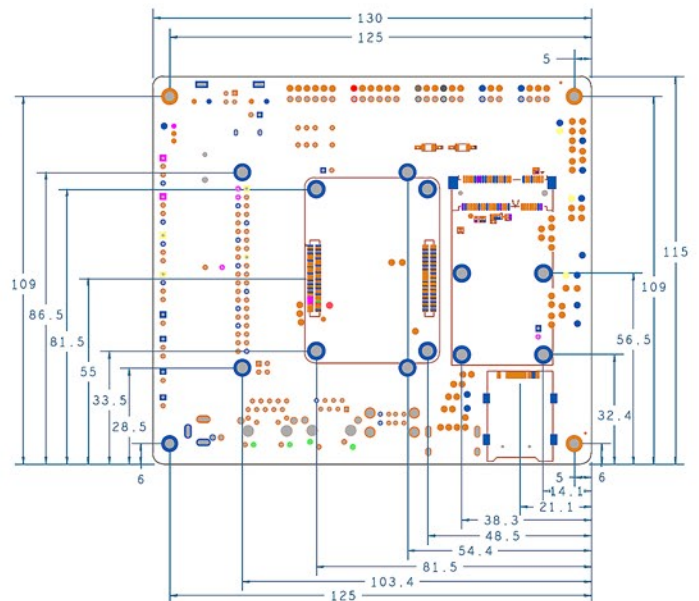
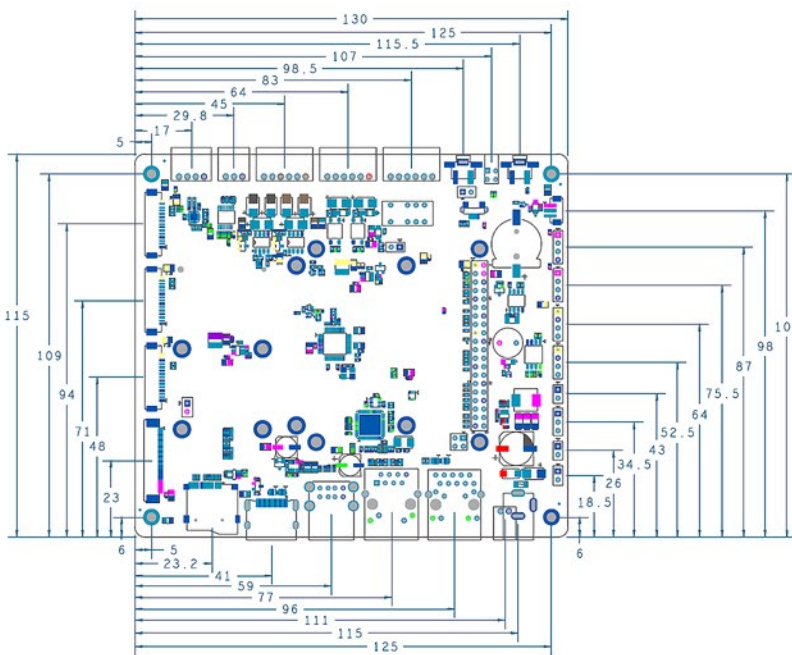
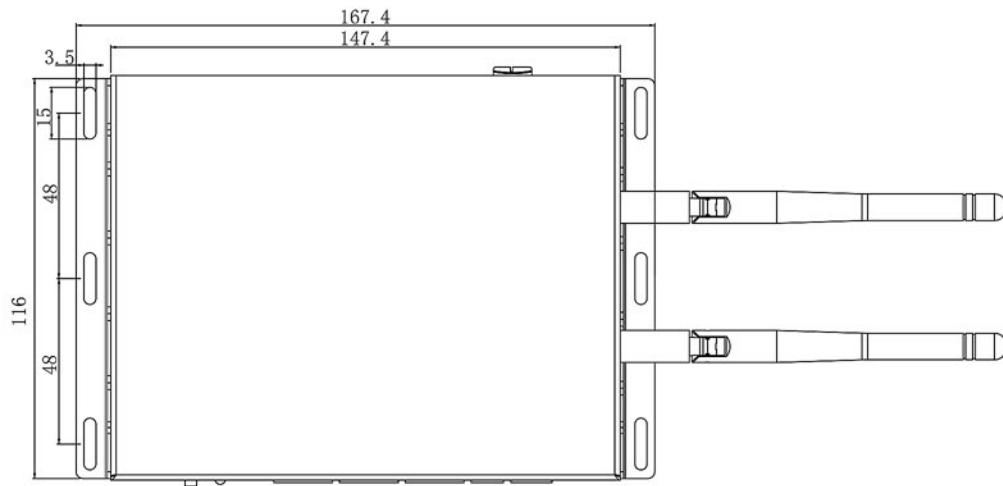
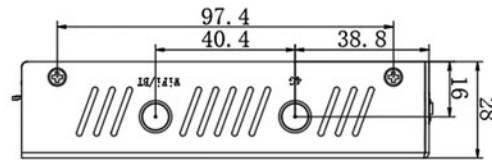
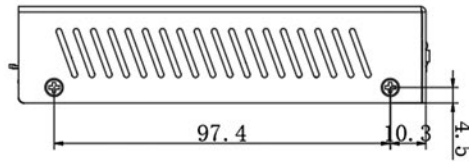

Order Information

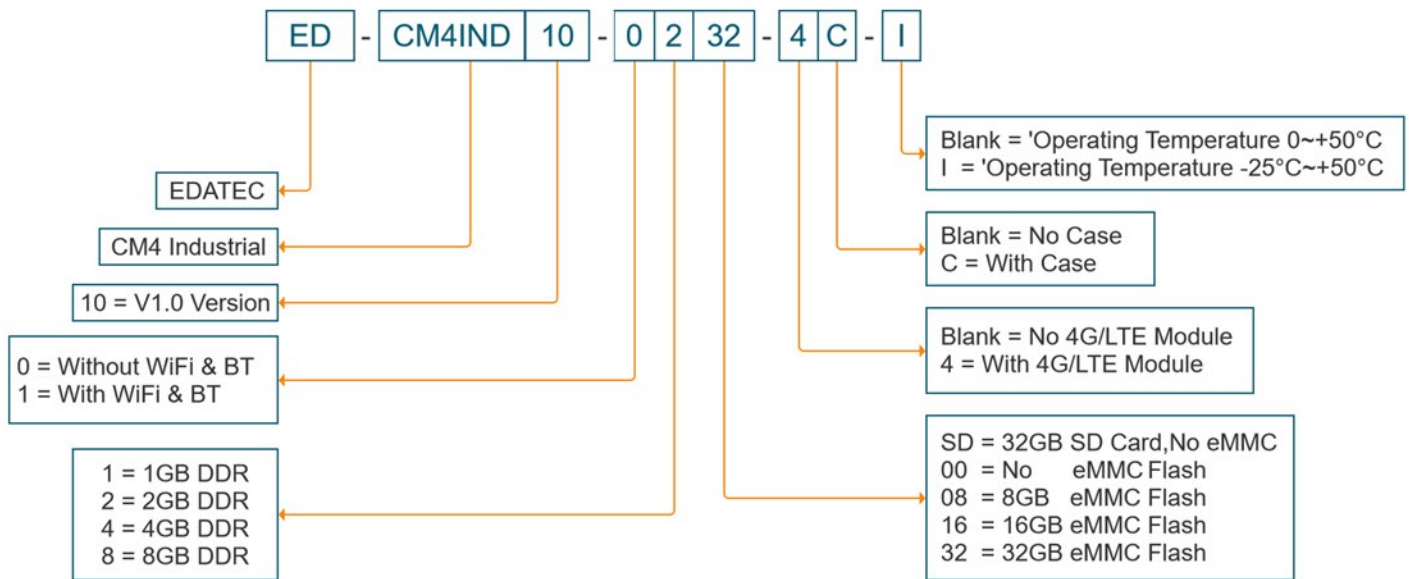

Example

Part#: ED-CM4IND10-1232-4C-I

Configuration: CM4 Industrial Computer V1.0 version
 1pcs Raspberry Pi certified WiFi/Bluetooth Antenna
 CM4102032 Compute Module with Wireless, 2GB DDR & 32GB eMMC
 4G Module with 1pcs 4G antenna
 Metal Case
 Operating Temperature: -25°C~+50°C

Contact Information

If you have any technical problems, please contact:

Support:support@edatec.cn

Business related, such as Quotation, Product Customization, please contact:

Sales:sales@edatec.cn

Web:www.edatec.cn

E-mail:sales@edatec.cn

Tel / Mobile / Fax:+86 - 18621560183

Address:Room 301, Building 24, No. 1661, Jialuo Road, Jiading District, Shanghai.

